

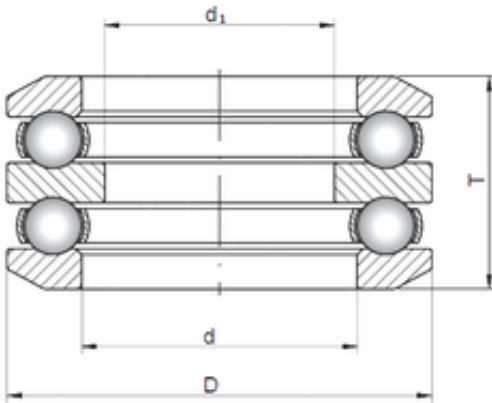

ISO 54413 thrust ball bearings



Bearing No. 54413

Size	68x140x109.4 mm
Bore Diameter	68 mm
Outer Diameter	140 mm
Width	109,4 mm
d	68 mm
d1	50 mm
D	140 mm
T	109,4 mm

54413 Bearing 2D drawings and 3D CAD models